

Hofstra University Interlibrary Loan



ILLiad TN: 70110

Borrower: RRR

Lending String: RVE,VQM,*ZIH,YRM,XFM

Patron: Yu, Ting

Journal Title: Progress in optics.

Volume: 43 **Issue:**
Month/Year: 2002**Pages:** 497-530

Article Author:

Article Title: Robert Boyd and Daniel J Gauthier;
'Slow' and 'fast' light

Imprint: Amsterdam ; North-Holland Pub. Co.,
1961

ILL Number: 19379304



Call #: QC351 .P7 vol. 43

Location: 8th Floor / Free

ARIEL

Charge

Maxcost: \$35IFM

Shipping Address:

UNIV. OF ROCHESTER

ILL LIBRARY

755 Library Rd BOX 270055

Rochester, NY 14627-0055

Fax:

Ariel: 128.151.244.106

Wilkie, J. and P. Bruner, 2000, *Phys. Rev. A* **61**, 064101.
Wiseman, H.M., F.E. Harrison, M.J. Collett, S.M. Tan, D.F. Walls and R.B. Kilip, 1997, *Phys. Rev. A* **56**, 55.
Wódkiewicz, K., 1984, *Phys. Rev. Lett.* **52**, 1064.
Wódkiewicz, K., 1995, *Phys. Rev. A* **51**, 2785.
Wódkiewicz, K., and G.H. Hebling, 1998, *Phys. Rev. A* **57**, 815.
Wolf, K.B., M.A. Alonso and G.W. Forbes, 1999, *J. Opt. Soc. Am. A* **16**, 2476.
Wolf, K.B., and E.V. Kurmyshev, 1993, *Phys. Rev. A* **47**, 3365.
Wolf, K.B., and A.L. Rivera, 1997, *Opt. Commun.* **144**, 36.
Wünsche, A., 1996a, *Quantum Semiclass. Opt.* **8**, 343.
Wünsche, A., 1996b, *Phys. Rev. A* **54**, 5291.
Zurek, W.H., 2001, *Nature (London)* **412**, 712.

**Notice: This Material
May Be Protected By
Copyright Law
(Title 17 U.S. Code).**

*E. Wolf Progress in Optics 43
© 2002 Elsevier Science B.V.
All rights reserved*

Chapter 6

“Slow” and “fast” light

by

Robert W. Boyd

The Institute of Optics, University of Rochester, Rochester, NY 14627, USA

and

Daniel J. Gauthier

Department of Physics, Duke University, Durham, NC 27708, USA

Contents

	Page
§ 1. Elementary concepts	499
§ 2. Optical pulse propagation in a resonant system	504
§ 3. Nonlinear optics for slow light	510
§ 4. Experimental studies of slow light	514
§ 5. Experimental studies of fast light	523
§ 6. Discussion and conclusions	528
Acknowledgements	528
References	529

§ 1. Elementary concepts

Recent research has established that it is possible to exercise extraordinary control of the velocity of propagation of light pulses through a material system. Both extremely slow propagation (much slower than the velocity of light in vacuum) and fast propagation (exceeding the velocity of light in vacuum) have been observed. This article summarizes this recent research, placing special emphasis on the description of the underlying physical processes leading to the modification of the velocity of light.

To understand these new results, it is crucial to recall the distinction between the phase velocity and the group velocity of a light field. These concepts will be defined more precisely below; for the present we note that the group velocity gives the velocity with which a pulse of light propagates through a material system. One thus speaks of “fast” or “slow” light depending on the value of the group velocity v_g in comparison to the velocity of light c in vacuum.

Slow light refers to the situation $v_g \ll c$. In fact, group velocities smaller than 17 m/s have been observed experimentally (Hau, Harris, Dutton and Behroozi [1999]). Fast light refers to light traveling faster than the speed of light in vacuum. This circumstance can occur either when $v_g > c$ or when v_g is negative. A negative group velocity corresponds to the case when the peak of the pulse transmitted through an optical material emerges *before* the peak of the incident light field enters the medium (Garrett and McCumber [1970]), which is indeed fast!

Some of these ideas can be understood in terms of the time sequences shown in fig. 1. It is also worth noting that the transit time T through an optical medium can in general be represented as

$$T = \frac{L}{v_g}, \quad (1)$$

where L is the physical length of the medium. Thus, when v_g is negative, the transit time through the medium will also be negative. The validity of the description given here and leading to fig. 1 assumes that the pulse does not undergo significant distortion in propagating through the material system. We shall comment below on the validity of this assumption.

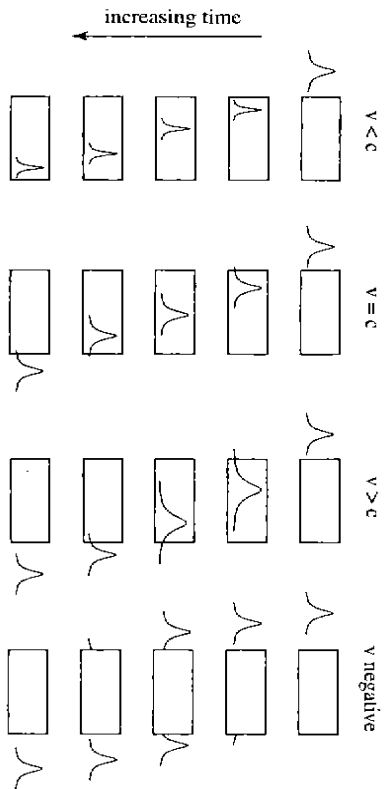

Fig. 1. Schematic representation of a pulse propagating through a medium for various values of the group velocity. In each case we depict the spatial variation of the pulse intensity for increasing values of time.

We next review the basic concepts of phase and group velocity. We begin by considering a monochromatic plane wave of angular frequency ω propagating through a medium of refractive index n . This wave can be described by

$$E(z, t) = A e^{i(kz - \omega t)} + \text{c.c.}, \quad (2)$$

where $k = n\omega/c$. We define the phase velocity v_p to be the velocity at which points of constant phase move through the medium. Since the phase of this wave is clearly given by

$$\phi = kz - \omega t, \quad (3)$$

points of constant phase move a distance Δz in a time Δt , which are related by

$$k\Delta z = \omega\Delta t. \quad (4)$$

Thus $v_p = \Delta z/\Delta t$ or

$$v_p = \frac{\omega}{k} = \frac{c}{n}. \quad (5)$$

Let us next consider the propagation of a pulse through a material system. A pulse is necessarily composed of a spread of optical frequencies, as illustrated symbolically in fig. 2. At the peak of the pulse, the various Fourier components will tend to add up in phase. If this pulse is to propagate without distortion, these

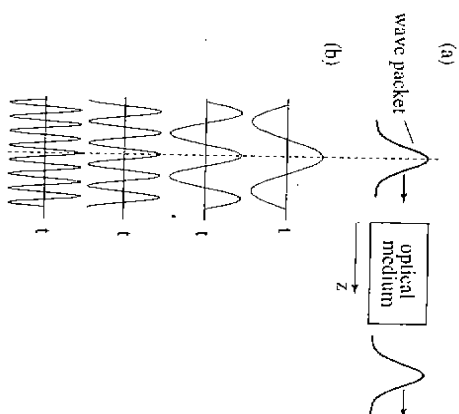

Fig. 2. Schematic representation of an optical pulse in terms of its various spectral components. Note that these contributions add in phase at the peak of the pulse.

components must add in phase for all values of the propagation distance z . To express this thought mathematically, we first write the phase of the wave as

$$\phi = \frac{n\omega z}{c} - \omega t, \quad (6)$$

and require that there be no change in ϕ to first order in ω . That is, $d\phi/d\omega = 0$ or

$$\frac{dn}{d\omega} \frac{\omega z}{c} + \frac{nz}{c} - t = 0, \quad (7)$$

which can be written as $z = v_g t$ where the group velocity is given by

$$v_g = \frac{c}{n + \omega \frac{dn}{d\omega}} = \frac{d\omega}{dk}. \quad (8)$$

The last equality in this equation results from the use of the relation $k = n\omega/c$. Alternatively, we can express this result in terms of a group refraction index n_g defined by

$$v_g = \frac{c}{n_g}, \quad (9)$$

with

$$n_g = n + \omega \frac{dn}{d\omega}. \quad (10)$$

We see that the group index differs from the phase index by a term that depends on the dispersion $dn/d\omega$ of the refractive index.

Slow and fast light effects invariably make use of the rapid variation of refractive index that occurs in the vicinity of a material resonance. Slow light can be achieved by making $dn/d\omega$ large and positive (large normal dispersion), and fast light occurs when it is large and negative (large anomalous dispersion)¹.

1.1. Pulse distortion

What is perhaps most significant about recent research in slow and fast light is not the size of the effect (that is, how fast or how slow a pulse can be made to propagate) but rather the realization that pulses can propagate through a highly dispersive medium with negligible pulse distortion. Let us examine why it is that pulse distortion effects can be rendered so small.

In theoretical treatment of pulse propagation (Boyd [1992]), it is often convenient to expand the propagation constant $k(\omega)$ in a power series about the central frequency ω_0 of the optical pulse as

$$k(\omega) = k_0 + k_1(\omega - \omega_0) + \frac{1}{2}k_2(\omega - \omega_0)^2 + \dots, \quad (11)$$

where $k_0 = k(\omega_0)$ is the mean wavevector magnitude of the optical pulse,

$$k_1 = \left. \frac{dk}{d\omega} \right|_{\omega=\omega_0} = \frac{1}{v_g} = \frac{n_g}{c} \quad (12)$$

is the inverse of the group velocity, and

$$k_2 = \left. \frac{d^2k}{d\omega^2} \right|_{\omega=\omega_0} = \frac{d(1/v_g)}{d\omega} = -\frac{1}{c} \frac{dn_g}{d\omega} \quad (13)$$

is a measure of the dispersion in the group velocity. Since the transit time through a material medium of length L is given by $T = Lv_g = Lk_1$, the spread in transit times is given approximately by

$$\Delta T \simeq Lk_2\Delta\omega, \quad (14)$$

where $\Delta\omega$ is a measure of the frequency bandwidth of the pulse.

The significance of each of the terms of the power series can be understood, for example, by considering solutions to the wave equation for a transform-

¹ We use the terms normal dispersion and anomalous dispersion to describe the change in the refractive index as a function of frequency (the traditional usage). In more recent texts on optical-fiber communication systems, the terms normal or anomalous dispersion refer to the change in the group index as a function of frequency. Normal (anomalous) group-velocity dispersion is the case when $dn_g/d\omega > 0$ ($dn_g/d\omega < 0$).

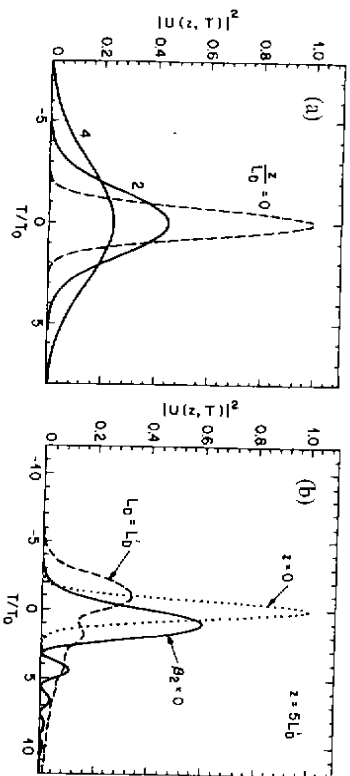

Fig. 3. Effects of group-velocity dispersion and higher-order dispersion on a Gaussian shaped pulse, from Agrawal [1995]. (a) Dispersion-induced broadening of a Gaussian pulse propagating through glass at $z = 2L_D$ and $z = 4L_D$. The dashed curve shows the incident pulse envelope. (b) Influence of higher-order dispersion. Pulse shapes at $z = 5L_D$ for an initially Gaussian pulse at $z = 0$ are shown. The solid curve is for the case when $k_2 = 0$ (β_2 in the notation of Agrawal) in the presence of higher-order dispersion; the dashed curve is the case when the characteristic length associated with group-velocity dispersion L_D and higher-order dispersion L_D' are equal. The dotted curve shows the incident pulse envelope.

limited Gaussian-shaped pulse (of characteristic pulse width T_0) incident upon a dispersive medium (Agrawal [1995]). When the propagation distance through the medium is much shorter than the dispersion length

$$L_D = \frac{T_0^2}{|k_2|}, \quad (15)$$

the pulse remains essentially undistorted and travels at the group velocity. For longer propagation distances (or shorter T_0 and larger $\Delta\omega$), the pulse broadens but retains its Gaussian shape, as shown in fig. 3a. In addition, the pulse acquires a linear frequency chirp; that is, the instantaneous frequency of the light varies linearly across the pulse about the central carrier frequency of the pulse. Red (blue) components travel faster than blue (red) components in the normal (anomalous) group-velocity dispersion regime where $k_2 > 0$ ($k_2 < 0$).

For situations where $k_2 \simeq 0$ or for large $\Delta\omega$, higher-order terms in the power series expansion (11) must be considered. It is found that an incident Gaussian pulse becomes distorted significantly, as shown in fig. 3b, when the pulse propagates farther than a characteristic distance

$$L_D' = \frac{T_0^3}{|k_3|}, \quad (16)$$

associated with higher-order dispersion, where $k_3 = d^3k/d\omega^3$.

To observe pulse propagation through a dispersive medium without significant pulse distortion, it is necessary that the spread of transit times ΔT given by eq. (14) be much smaller than the characteristic pulse duration T_0 . As discussed below, experiments on slow and fast light are typically conducted under conditions such that the group index n_g is an extremum, so that $dn_g/d\omega = 0$ and hence k_2 vanishes. It is for this reason that slow- and fast-light experiments are accompanied by negligible distortion so long as the propagation distance through the dispersive medium is much less than L_D (implying a narrow spectral bandwidth for the pulse). Limitations to the accuracy of the group-velocity description for propagation through an absorptive medium have been pointed out by Xiao and Oughstun [1997, 1999].

§ 2. Optical pulse propagation in a resonant system

Propagation of light pulses through resonant atomic systems has attracted great interest since the early 1900's because of the possibility of fast-light behavior and its implications for Einstein's Special Theory of Relativity. Sommerfeld, independently (Sommerfeld [1907, 1914]) and together with his student Brillouin (Brillouin [1914]), developed a complete theory of pulse propagation through a collection of Lorentz oscillators. Their work was published during World War I and is not widely available. For this reason, Brillouin compiled and augmented their earlier work in a beautiful treatise entitled *Wave propagation and group velocity* (Brillouin [1960]). They were most interested in the case in which the carrier frequency of the pulse coincides with the atomic resonance so that the pulse experiences anomalous dispersion and consequently $v_g > c$. They considered the case of an optical pulse that has an initial rectangular shape so that its amplitude vanishes before the beginning of the pulse — the so-called front of the pulse. They found that the speed of the front of the pulse is always equal to the speed of light in vacuum even in the anomalous-dispersion regime where $v_g > c$ or $v_g < 0$, and that the pulse experiences substantial distortion. In hindsight, the fact that the pulse experiences distortion is due to the wide bandwidth of the pulse resulting from the infinitely sharp turn on.

To understand the unusual slow and fast light properties of pulse propagation through resonant systems, we review the solutions to the wave equation, paying particular attention to the manner in which the refractive index is modified in the immediate vicinity of each transition frequency. We express the refractive index

$$n = \sqrt{\epsilon} = \sqrt{1 + 4\pi\chi}, \quad (17)$$

where ϵ is the dielectric constant, and the susceptibility is given (in Gaussian units) by

$$\chi = \frac{Ne^2/2m\omega_0}{(\omega_0 - \omega) - i\gamma}, \quad (18)$$

for a near resonant light field. The transition frequency is denoted by ω_0 , 2γ is the width (FWHM) of the atomic resonance, and e (m) denote the charge (mass) of the electron. For an atomic number density N that is not too large, the refractive index $n = n' + in''$ can be expressed as $n \simeq 1 + 2\pi\chi$, whose real and imaginary parts are given by

$$n' = 1 + \frac{\pi Ne^2}{2m\omega_0\gamma} \frac{2(\omega_0 - \omega)\gamma}{(\omega_0 - \omega)^2 + \gamma^2} \equiv 1 + \delta n^{(\text{max})} \frac{2(\omega_0 - \omega)\gamma}{(\omega_0 - \omega)^2 + \gamma^2}, \quad (19)$$

$$n'' = \frac{\pi Ne^2}{2m\omega_0\gamma} \frac{\gamma^2}{(\omega_0 - \omega)^2 + \gamma^2} \equiv \delta n^{(\text{max})} \frac{\gamma^2}{(\omega_0 - \omega)^2 + \gamma^2}, \quad (20)$$

where $\delta n^{(\text{max})}$ is the maximum deviation of the phase index from unity. These functional dependences are shown in fig. 4, along with the group index

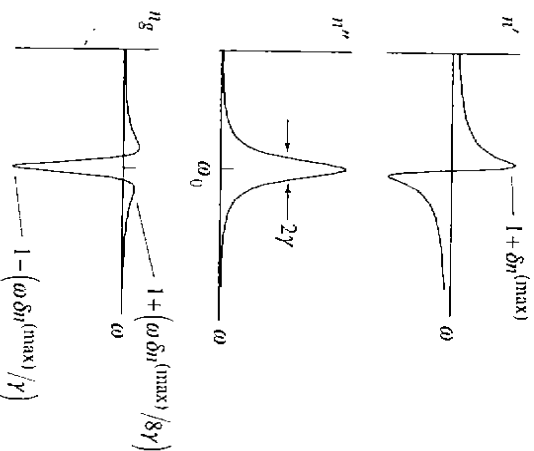

Fig. 4. The real (n') and imaginary (n'') parts of the phase index and the real part of the group index (n_g) associated with an isolated atomic resonance.

$n_g = n' + \omega \, dn'/d\omega$. Note that the scale of the variation of the group index from unity is given by the quantities

$$\delta n_g^{(\max)} = \frac{\omega \delta n^{(\max)}}{8\gamma}, \quad \delta n_g^{(\min)} = \frac{\omega \delta n^{(\max)}}{\gamma}. \quad (21)$$

Typical values for an atomic vapor are $\omega = 2\pi (5 \times 10^{14}) \text{ s}^{-1}$, $\delta n^{(\max)} = 0.1$, and $\gamma = 2\pi (1 \times 10^9) \text{ s}^{-1}$, leading to the value

$$\delta n_g^{(\max)} = 5 \times 10^{-4}. \quad (22)$$

This is a remarkable result! Even though phase indices of atomic vapors are rarely larger than 1.5 (and the phase index is 1.1 for the numerical example just given) the group index can be of the order of 5×10^4 . Group indices this large are not routinely measured in atomic vapors because of the large absorption that occurs at frequencies where n_g is appreciable. As one can deduce from eq. (20), the linear absorption coefficient $\alpha = 2n''\omega/c$ is of the order of 10^4 cm^{-1} under the same conditions used to obtain result (22).

2.1. Early observations of 'slow' and 'fast' light propagation

While there was considerable theoretical interest in pulse propagation through resonant systems over a 100 years ago, experimental investigations in the optical spectral region increased substantially with the advent of the laser. In 1966 Basov, Ambartsumyan, Zuev, Kryukov and Letokhov [1966] and Basov and Letokhov [1966] investigated the propagation of a pulse propagating through a laser amplifier (a collection of inverted atoms) for the case in which the intensity of the pulse was high enough to induce a nonlinear optical response. They found that nonlinear optical saturation of the amplifier gave rise to fast light, a surprising result since the linear dispersion is normal at the center of an amplifying resonance so that $v_g < c$ is expected for low intensity pulses. They attributed the pulse advancement to a nonlinear pulse reshaping effect where the front edge of the pulse depletes the atomic inversion density so that the trailing edge propagates with much lower amplification. In addition, they found that the effects of dispersion give a negligible contribution to the pulse propagation velocity in comparison to the nonlinear optical saturation effects. Such pulse advancement due to amplifier saturation is now commonly referred to as *superluminal* propagation. Throughout this review, we are mainly concerned with propagation of pulses that are sufficiently weak so that the *linear* optical

properties of the medium need only be considered, although these properties may be modified in a nonlinear fashion by the application of an intense auxiliary field.

Soon after the experiment of Basov, Ambartsumyan, Zuev, Kryukov and Letokhov [1966], Isevgi and Lamb [1969] performed a theoretical investigation of the propagation of intense laser pulses through a laser amplifier. They attempted to resolve the apparent paradox of pulses propagating "faster than the velocity of light" predicted in the work of Basov and Letokhov [1966], and it appears that Isevgi and Lamb were unaware of the earlier work by Brillouin [1914] discussing the distinction between group velocity and front velocity and its implications for the Special Theory of Relativity. Isevgi and Lamb distinguish between two types of pulses in their work. A pulse is said to have compact support if its amplitude is nonzero only over some finite range of times, and is said to have infinite support if the pulse is nonzero for all times. By way of example, a hyperbolic secant pulse has infinite support. Isevgi and Lamb find in their numerical solutions of the pulse propagation equation that pulses with infinite support can propagate with group velocities exceeding that of light in vacuum c . However, there is no violation of causality because the input pulse exists for all values of time. For a pulse with compact support, they find that the region of the pulse where it first becomes nonzero cannot propagate faster than c (the front velocity in the terms of Brillouin [1914]). Their results are consistent with the work of Brillouin [1914] and extend the analysis to a nonlinear optical medium.

These issues have been clarified further in the work of Sherman and Oughstun [1981], who present a simple algorithm for the description of short pulse propagation through dispersive systems in the presence of loss. More recently, Diener [1996] shows that in cases in which a pulse propagates superluminally, that part of the pulse which propagates faster than c can be predicted by means of analytic continuation of that part of the pulse that lies within the "light cone", that is, the extreme leading wing of the pulse. In subsequent work, Diener [1997] introduced an energy transport velocity

$$c_1 = \frac{2n}{1+n^2}c, \quad (23)$$

which is less than or equal to c for any value of n .

Subsequent experiments conducted in the late 1960s by Carruthers and Bieber [1969] and Froya, Duguay, Garrett and McCall [1969], and in early the 1970s by Faxvog, Chow, Bieber and Carruthers [1970] on weak pulses propagating through amplifying media observed slow light as expected for a linear amplifier.

However, the effect was small because of the smallness of the available gain. Using a high-gain 3.51- μm xenon amplifier, Casperson and Yariv [1971] were able to achieve group velocities as low as $c/2.5$.

In this same period, Garrett and McCumber [1970] made an important contribution to the field when they investigated theoretically the propagation of a weak Gaussian pulse through either an amplifier or absorber. They were the first to point out that the pulse remains substantially Gaussian and unchanged in width for many exponential absorption or gain lengths and that the location of the maximum pulse amplitude propagates at v_g , even when $v_g > c$ or $v_g < 0$. For this distortion-free propagation, the spectral bandwidth of the pulse has to be narrow enough so that higher-order dispersive effects are not important, as discussed in § 1.1. Note that a Gaussian pulse is of infinite support and hence the predictions of Garrett and McCumber [1970] are consistent with the earlier work of Lesevje and Lamb [1969].

Following up on the predictions of Garrett and McCumber [1970], Chu and Wong [1982a] investigated experimentally both slow and fast light for picosecond laser pulses propagating through a GaP:N crystal as the laser frequency was tuned through the absorption resonance arising from the bound A -exciton line. Typical experimental traces are shown in fig. 5 and are summarized in fig. 6. Both positive and negative group delays are observed and the pulse shape remains essentially unchanged. The data points are found to be in good agreement with the theoretical predictions, which were obtained from a model that is a slight generalization of the model presented above. Note that the fast light observed in this experiment was obtained in the presence of a large absorptive background. This report is of significance in that it is one of the first studies to establish experimentally that the group velocity is a robust concept in the optical part of the spectrum even under conditions of significant pulse advance or delay.

We note that the pulse shapes observed by Chu and Wong [1982a] and shown in fig. 5 are affected by the measurement process, as pointed out by Katz and Allano [1982]. The pulse shapes were measured using an autocorrelation method, which is insensitive to pulse asymmetries or oscillations, but is sensitive to pulse compression. Katz and Allano find that the pulses shown in fig. 5 experience significant compression, which may be due to true compression or due to pulse asymmetries. In response, Chu and Wong [1982b] agree that pulse compression is present in their data and can be explained theoretically by the inclusion of higher order dispersion. However, they also point out that the group velocity remains a meaningful concept even in the presence of pulse compression. Later numerical simulations by Segard and Mäcke [1985] of

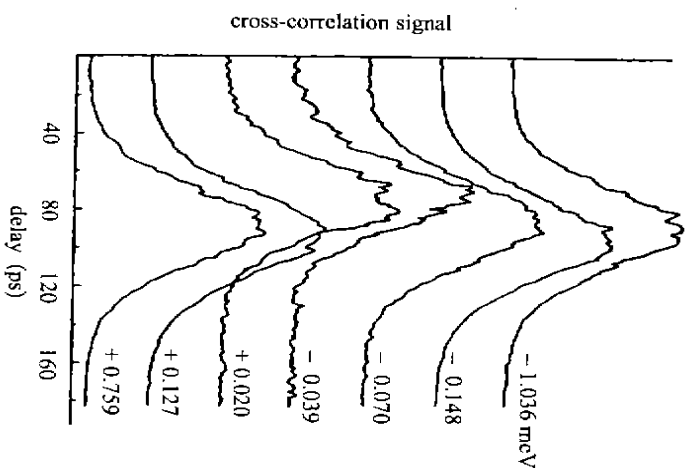

Fig. 5. Experimental results of Chu and Wong [1982a] showing the transmitted pulse shapes as their laser frequency is tuned through an excitation resonance line in GaP:N.

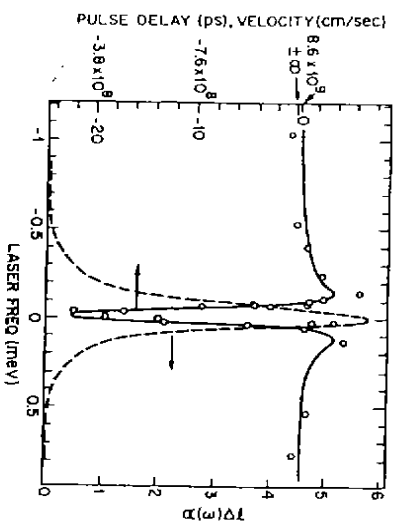

Fig. 6. Summary of the experimental results of Chu and Wong [1982a] demonstrating that the group delay can be either positive or negative (solid line). For comparison the absorption spectrum of their sample is also shown (dashed line).

the experiments of Chu and Wong [1982a] show that the pulses experience significant ringing, not just compression as suggested by Chu and Wong [1982b]. In the same paper, Segard and Macke [1985] also describe a fast-light experiment via a millimeter wave absorption resonance in OCS. They observe significant pulse advancement and negative group velocities with essentially no pulse distortion using a detector that directly measured the pulse shape, confirming the theoretical predictions of Garrett and McCumber [1970]. As in the previous experiments, the pulses experienced large absorption.

§ 3. Nonlinear optics for slow light

The conclusion of the previous sections is that in linear optics the group refractive index can be as large as

$$\delta n_g = 1 + \frac{(\partial \delta n / \partial \rho)^{(\max)}}{8\gamma} \quad \text{where} \quad \delta n^{(\max)} = \frac{\pi N e^2}{m \omega_0^2 \gamma}, \quad (24)$$

but is accompanied by absorption of the order of

$$\alpha \simeq \frac{4\pi \delta n^{(\max)}}{\lambda}, \quad (25)$$

where λ is the vacuum wavelength of the radiation. Recent demonstrations of slow light have been enabled by nonlinear optical techniques which can be used to decrease the effective linewidth γ of the atomic transition and also to decrease the level of absorption experienced by the pulse. A typical procedure for producing slow light is to make use of electromagnetically induced transparency (EIT), a technique introduced by Harris, Field and Imamoglu [1990] to render a material system transparent to resonant laser radiation, while retaining the large and desirable optical properties associated with the resonant response of a material system. See also review articles by Harris, Yin, Jain, Xia and Metriam [1997], Harris [1997], and Lukin and Imamoglu [2001].

The possibility of modifying the linear dispersive properties of an atomic medium using an intense auxiliary electromagnetic field was first noted by Tewari and Agarwal [1986] and by Harris, Field and Imamoglu [1990]. In addition, Scully [1991] pointed out that the refractive index can be enhanced substantially in the absence of absorption using similar methods, with possible applications in magnetometry [1992]. In a later paper Harris, Field and Kasapi [1992] performed detailed calculations to estimate the size of the slow-light effect. They estimate

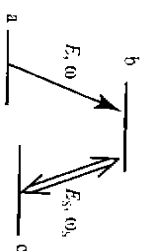

Fig. 7. Energy-level structure utilized in a typical EIT, slow-light experiment.

that $v_g = c/250$ could be obtained for a 10-cm-long Pb vapor cell at an atom density of 7×10^{15} atoms/cm³ and probed on the 283-nm resonance transition. This small group velocity is accompanied by essential zero absorption and zero group-velocity dispersion. More recently, Bennink, Boyd, Stroud and Wong [2001] have predicted that slow- and fast-light effects can be obtained in the response of a strongly driven two-level atom.

Following an approach similar to that used by Harris, Field, and Kasapi, we review the relation between EIT and slow light using a density matrix calculation. We consider the situation shown in fig. 7, and for simplicity assume that in the absence of the applied laser fields all of the population resides in level a . We want to solve the density matrix equations to first order in the amplitude E of the probe wave and to all orders in amplitude E_s of the saturating wave. In this order of approximation, the only matrix elements that couple to ρ_{aa} (which can be taken to be constant) are ρ_{ba} and ρ_{ca} , which satisfy the equations

$$\dot{\rho}_{ba} = -(i\omega_{ba} + \gamma_{ba})\rho_{ba} - \frac{i}{\hbar} (V_{ba}\rho_{aa} + V_{bc}\rho_{ca}), \quad (26)$$

$$\dot{\rho}_{ca} = -(i\omega_{ca} + \gamma_{ca})\rho_{ca} - \frac{i}{\hbar} (V_{cb}\rho_{ba}), \quad (27)$$

In the rotating-wave and electric-dipole approximations, $V_{ba} = -\frac{1}{2}\mu_{ba}E_s e^{-i\omega_s t}$ and $V_{bc} = -\frac{1}{2}\mu_{bc}E_s e^{-i\omega_s t}$. We now solve these equations in the harmonic steady state, that is, we find solutions of the form

$$\rho_{ba} = O_{ba} e^{-i\omega t}, \quad \rho_{ca} = O_{ca} e^{-i(\omega_s - \omega)t}, \quad (28)$$

where O_{ba} and O_{ca} are time-independent quantities. We readily find that

$$O_{ba} = \frac{-i(\Omega/2)[i(\delta - \Delta) - \gamma_{ca}]}{(i\delta - \gamma_{ba})[i(\delta - \Delta) - \gamma_{ca}] + |\Omega_s/2|^2}, \quad (29)$$

where $\delta = \omega - \omega_{ba}$, $\Delta = \omega_s - \omega_{bc}$, and $\Omega_s = 2\mu_{bc}E_s/\hbar$ is the Rabi frequency associated with the strong drive field. From this equation, we determine the

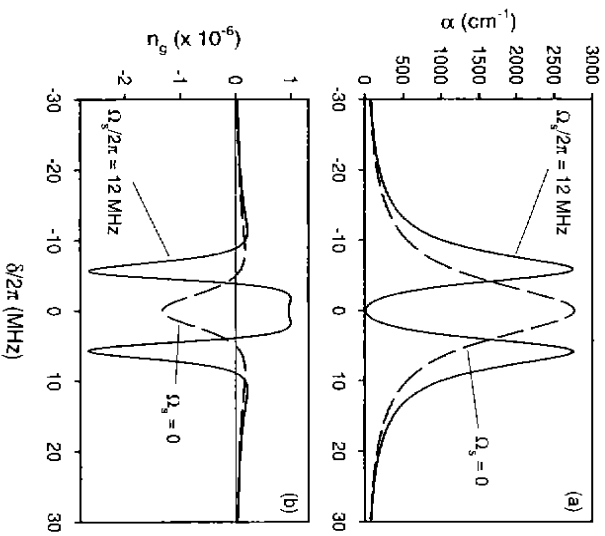

Fig. 8. Frequency dependence of (a) the absorption coefficient and (b) the group index in the absence (dashed curves) and in the presence (solid curves) of the intense coupling field that induces the EIT effect. The parameters are estimated from the conditions of the experiments of Hau, Harris, Dutton and Behroozi [1999] and are given by $2\pi N|H_{ba}|^2/\gamma_{ba}\hbar = 0.013$, $\gamma_{ca}/2\pi = 5$ MHz, $\gamma_{ca} = 0.038$ MHz, and $\omega^2/\gamma_{cb} = 1.02 \times 10^8$.

susceptibility for the probe wave by means of the equations $P = N\mu_{ab}^*O_{ba} = \chi^{(1)}E$, which, when solved for $\chi^{(1)}$, yields

$$\chi^{(1)} = \frac{-iN|\mu_{ba}|^2}{\hbar} \frac{[(\delta - \Delta) - \gamma_{ca}]}{(\delta - \gamma_{ba})[(\delta - \Delta) - \gamma_{ca}] + |\Omega_c/2|^2}. \quad (30)$$

Let us recall why this result leads to the prediction of EIT. For simplicity we assume that the strong saturating wave is tuned to the ω_{bc} resonance so that $\Delta = 0$. One finds that as the intensity of the saturating field (which is proportional to $|\Omega_c|^2$) is increased, the absorption line splits into two components separated by the Rabi frequency $|\Omega_c|$. Figure 8a shows $\alpha(\delta, \Delta = 0)$ for the experimental conditions of Hau, Harris, Dutton and Behroozi [1999] for two values of Ω_c to show the emergence of the EIT spectral "hole" at line center (i.e., $\delta = 0$). In detail, one finds that (for $\delta = \Delta = 0$)

$$\chi^{(1)} = \frac{iN|\mu_{ba}|^2\gamma_{ca}/\hbar}{\gamma_{ca}\gamma_{ba} + |\Omega_c/2|^2}. \quad (31)$$

Note that $\chi^{(1)}$ is purely imaginary, that $\chi^{(1)}$ is a monotonically decreasing function of $|\Omega_c|^2$, and for $|\Omega_c|^2 \gg \gamma_{ca}\gamma_{ba}$ that $\chi^{(1)}$ is proportional to γ_{ca} , which under many experimental conditions has very small value. Thus, the presence of the strong saturating field leads to transparency at the frequency of the probe field, although only over a narrow range of frequencies.

Let us also estimate the value of the group refractive index under EIT conditions. To good approximation, we ignore the first contribution in the expression $n_g = n' + \omega \, d n' / d \omega$ (here n' is the real part of the phase index n) and approximate the phase index by its low-density expression $n \simeq 1 + 2\pi\chi^{(1)}$. We take the expression for $\chi^{(1)}$ in the limit of large-field amplitude $|\Omega_c|$ and vanishing strong-field detuning ($\Delta = 0$) so that

$$\chi^{(1)} = \frac{-iN|\mu_{ba}|^2}{\hbar} \frac{i\delta - \gamma_{ca}}{|\Omega_c/2|^2}. \quad (32)$$

By combining these equations we find that

$$n_g \simeq \frac{8\pi\omega N|\mu_{ba}|^2}{\hbar|\Omega_c|^2}. \quad (33)$$

Equation (33) was used by Hau, Harris, Dutton and Behroozi [1999] in the analysis of their experimental results. They find that it gives predictions that are in reasonably good agreement with their experimental data. Note, however, from their fig. 4, that the scaling of group velocity with drive-field intensity is not accurately described by eq. (33) for a range of temperatures slightly above the Bose-Einstein transition temperature.

Figure 8b shows $n_g(\delta, \Delta = 0)$ for two values of Ω_c . For $\Omega_c = 0$, the group index is extremely large and negative, but this is accompanied by extremely large absorption (see fig. 8a). The curve is dramatically different for $\Omega_c/2\pi = 12$ MHz, taking on a large positive value of the order of 10^6 with little dispersion and absorption. The group velocity at $\delta = 0$ corresponds to approximately 300 m/s. For lower Ω_c , v_g as low as 17 m/s were observed by Hau, Harris, Dutton, and Behroozi, although with slightly increased absorption.

3.1. Kinematics of slow light

While we noted above that a smooth pulse can propagate undistorted through a medium with an EIT hole, the fact that the pulse travels with such slow speed implies that the light pulse undergoes an enormous spatial compression, as pointed out by Harris, Field and Kasapi [1992] and illustrated schematically

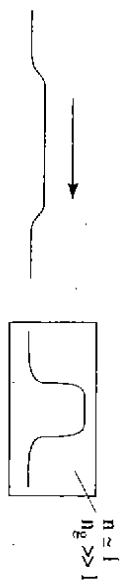

Fig. 9. Schematic illustration of pulse compression that occurs when a pulse enters a medium with a low group velocity.

in fig. 9. In particular, the pulse undergoes a spatial compression by the ratio of the group velocities inside and outside of the optical medium. Since the group velocity in vacuum is equal to c , this ratio is just the group index n_g of the material medium, which as we have seen can be as large as $\simeq 10^7$. Since the energy density of a light wave is given (in SI units) by

$$u = \frac{1}{2} \epsilon_0 n_g |E|^2, \quad (34)$$

one sees that the energy density increases by this same factor. However, the intensity (power per unit area) of the beam remains the same as the pulse enters the medium, as one can see from the relation

$$I = u v_g. \quad (35)$$

One also sees that the electric field strength remains (essentially) constant as the pulse enters the material medium, as can be seen from the relation

$$I = \frac{1}{2} \epsilon_0 c n |E|^2, \quad (36)$$

and there is little if any discontinuity in n at the boundary of the medium. These results have been discussed in greater detail by Harris and Hau [1999]. Their report also notes that large nonlinear optical effects often accompany the creation of slow light. One sees from the discussion just given that the linear response tends to be large $n\omega$ because the electric field is enhanced within the optical medium but rather because the conditions that produce slow light also tend to produce a large nonlinear optical susceptibility.

§ 4. Experimental studies of slow light

One of the first experiments to measure the dispersive properties of an EIT system was performed by Xiao, Li, Jin and Gea-Banacloche [1995] using a gas of hot rubidium atoms and using a slightly different energy

level configuration than that considered in the previous section. They directly measured the phase imparted on a wave propagating through the rubidium vapor and tuned near the $^5S_{1/2} \rightarrow ^3P_{3/2}$ transition using a Mach-Zehnder interferometer. A strong continuous wave laser beam tuned near the $^3P_{3/2} \rightarrow ^5D_{5/2}$ transition (the so-called 'ladder' configuration) and counterpropagating with the probe beam created a Doppler-free EIT feature, thereby reducing α and increasing n_g . While they did not directly measure the delay of pulses propagating through the vapor, they indirectly determined that $v_g = c/13.2$ for their experiment via the measurement of the phase shift of the wave.

Soon thereafter Kasapi, Jain, Yin and Harris [1995] measured the temporal and spatial dynamics of nanosecond pulses propagating through a hot, dense 10-cm-long Pb vapor cell in an EIT configuration similar to that described in the previous section. In the absence of a coupling field, they inferred a probe-beam absorption coefficient of 600 cm^{-1} . With the coupling field applied, they measured a probe-beam transmission of 55% (corresponding to $\alpha = 0.026 \text{ cm}^{-1}$) and $v_g = c/165$.

These initial experiments demonstrated that it is possible to achieve slow light with dramatically reduced absorption, and they set the stage for later experiments on ultraslow light where the group velocities are extremely small. The key to achieving lower group velocities was to reduce significantly the dephasing rate γ_{eff} of the ground-state coherence, thereby narrowing the width of the EIT feature and increasing $dn/d\omega$. As mentioned in § 1.1, narrowing the EIT feature requires the use of significantly longer pulses in comparison to the nanosecond pulsed used by Kasapi, Jain, Yin and Harris [1995].

4.1. Ultraslow light in a ultracold atomic gas

Hau, Harris, Dutton and Behroozi [1999] performed an experiment in 1999 that is largely responsible for the recent flurry of interest in slow light. This experiment made use of a laser-cooled sodium atomic vapor at a temperature of 450 nK near that of the transition to a Bose-Einstein condensation. The experimental setup for this study is shown in fig. 10. Briefly, they laser-cool and trap a cloud of atoms, spin-polarize the atoms by optically pumping them into the $|F = 1, m_F = -1\rangle$ $^3S_{1/2}$ ground state, and load the atoms into a magnetic trap at an approximate temperature of 50 μK and a density of $\sim 6 \times 10^{11} \text{ cm}^{-3}$. At such low temperatures, the Doppler width of the optical transitions is less than the natural (spontaneous) width of the transition and hence the stationary-atom theory presented in § 3 is applicable. The temperature is further decreased via

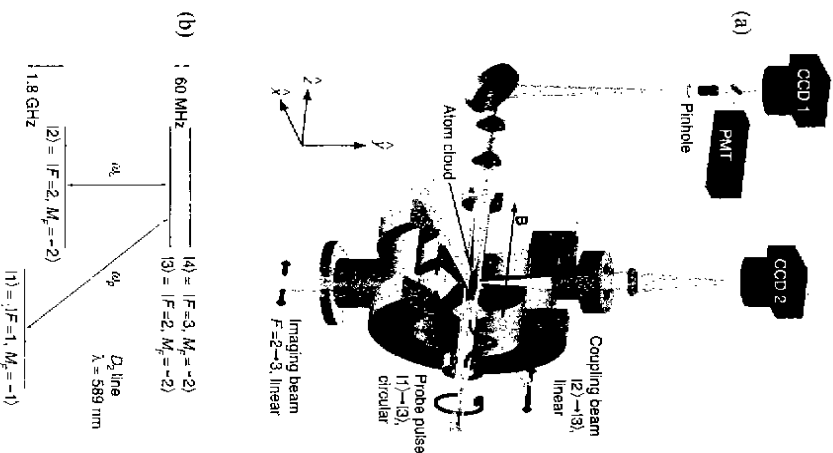

Fig. 10. (a) Experimental setup and (b) energy levels and laser frequencies used in the slow-light experiment of Hau, Harris, Dutton and Behroozi [1999].

evaporative cooling of the cloud, resulting in fewer trapped atoms but slightly higher atomic number densities and hence lower v_g . We note that the magnetic trap is asymmetric, leading to an oblong cloud of cold atoms.

In the slow-light phase of the experiment, a strong coupling laser at frequency ω_c drives the $|2\rangle \rightarrow |3\rangle$ transition of the sodium D_2 resonance line (see fig. 10b) and propagates along one of the short axes of the cloud, as shown in fig. 10a. The group velocity of a pulse of light of center-frequency ω_0 is then determined as it propagates along the long axis of the cloud. The group velocity is monitored as probe beam frequency is scanned through the $|1\rangle \rightarrow |3\rangle$ transition.

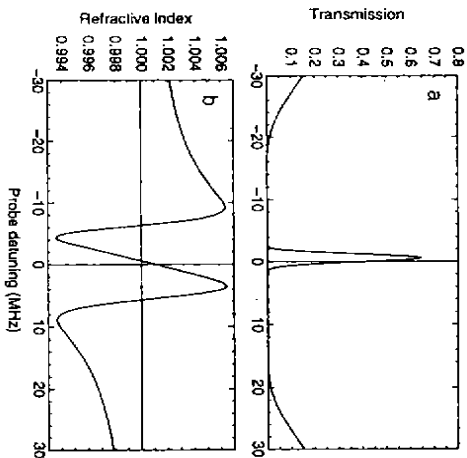

Fig. 11. (a) Theoretically predicted probe absorption spectrum, and (b) resulting modification of the phase refractive index under the experimental conditions of Hau, Harris, Dutton and Behroozi [1999].

The conceptual understanding of this method is illustrated in the theoretical simulations of the experiment shown in fig. 11. The upper part of this figure shows that a narrow transparency feature has been induced by the coupling field into the broad absorption profile of the gas. Note that this induced feature is of the order of 2 MHz in spectral width. Under their experimental conditions, the width of this feature is determined by power broadening effects (that is, the $(\Omega_c/2)^2$ term in eq. (38), although fundamentally the narrowness of this feature is limited by the relaxation rate between the $|1\rangle$ and $|2\rangle$ levels). The lower part of this figure shows the resulting modification of the refractive index of the vapor. Note the steep, nearly linear increase of refractive index with frequency near the transition frequency. It is this behavior that leads to the large group index of this system. In fact, Hau, Harris, Dutton and Behroozi [1999] shows that the group index is given (in the power-broadened limit) by the expression

$$v_g = \frac{\hbar c}{8\pi\omega_0} \frac{|\Omega_c|^2}{|u_{13}|^2 N}. \quad (37)$$

Note that the group velocity decreases with decreasing control field intensity so long as this expression is valid. Some of the results of this experiment are shown in fig. 12. Here the open circles show a transmitted pulse propagating at the velocity of light in vacuum and the solid circles show the pulse induced to propagate slowly. Note that the induced pulse delay is considerably

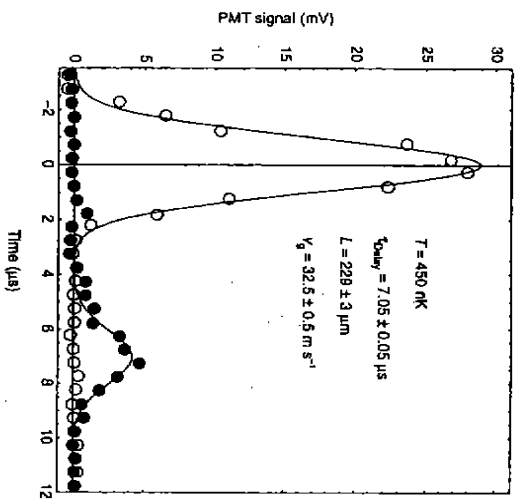

Fig. 12. Some of the experimental results of Han, Harris, Dutton and Behroozi [1999] demonstrating ultra-slow propagation of a light pulse. The open circles show the input pulse; the solid circles show the transmitted, delayed pulse.

greater than the duration of the pulse. In this example, the group velocity was measured to be 32.5 m/s corresponding to a group index of the order of 10^7 . In other measurements, these researchers observed group velocities as low as 17 m/s.

4.2. Slow light in hot vapors

One might incorrectly deduce that the experiment of Han, Harris, Dutton and Behroozi was enabled through use of a cold atomic gas. In fact, very similar experimental results have been obtained by Kash, Sautenkov, Zibrov, Hollberg, Welch, Lukin, Rostovtsev, Fry and Scully [1999] in a coherently driven hot ($T = 360$ K) gas of rubidium atoms using the apparatus shown in fig. 13. The key idea is that a narrow EIT resonance can be obtained by suppressing line-broadening mechanisms arising from the motion of the atoms and Zeeman splitting of the magnetic sublevels arising from stray magnetic fields.

The dominant broadening mechanism in a hot gas is the Doppler effect. The EIT resonance can be rendered Doppler-free by making the strong continuous-

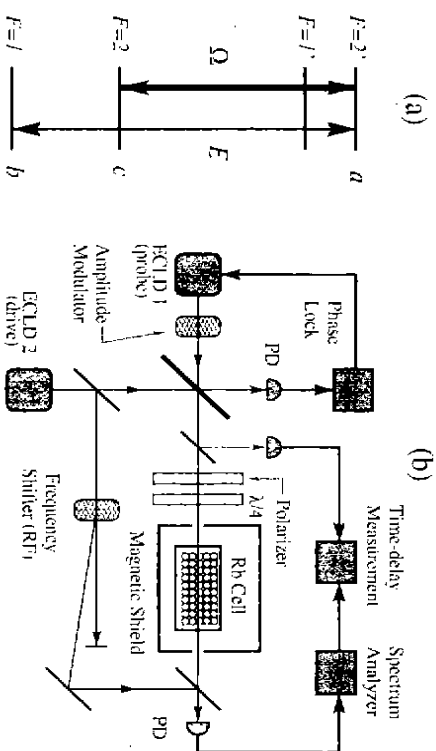

Fig. 13. Experimental set-up of Kash, Sautenkov, Zibrov, Hollberg, Welch, Lukin, Rostovtsev, Fry and Scully [1999] for creating EIT features in a dense hot atomic vapor of rubidium. Note that their notation for the atomic energy levels (part a of the figure) is different from that of § 3 of the present chapter.

wave coupling beam copropagate precisely with the probe beam. To see why this is the case, recall that the susceptibility for a hot gas is given by

$$\chi^{(1)} = \frac{-iN\langle |\mu_{ba}|^2 \rangle}{\hbar} \times \left\langle \frac{\{i[\delta - \Delta + (\vec{k} - \vec{k}_s) \cdot \vec{v}] - \gamma_{av}\}}{[i(\delta + \vec{k} \cdot \vec{v}) - \gamma_{ba}]\{i[\delta - \Delta + (\vec{k} - \vec{k}_s) \cdot \vec{v}] - \gamma_{av}\} + |\Omega_a/2|^2} \right\rangle_D \quad (38)$$

where \vec{k} (\vec{k}_s) is the propagation vector for the probe (saturating) beam, \vec{v} is the velocity of an atom, and $\langle \dots \rangle_D$ denote an average over the thermal velocity distribution. It is seen that the term in the numerator, primarily responsible for the EIT resonance, contains the difference of the two propagation vectors. A narrow EIT resonance can thus be obtained for copropagating, nearly equal frequency probe and saturating waves so that $(\vec{k} - \vec{k}_s)$ essentially vanishes. For this configuration, the condition for the formation of a well-defined EIT hole is given approximately by $|\Omega_a|^2 \gg \gamma_{av}\Delta\omega_D$, where $\Delta\omega_D$ is the Doppler width of the transition. Therefore, it is imperative to reduce γ_{av} as much as possible.

For a single stationary atom, $\gamma_{av}/2\pi$ can be of the order of 1 Hz or less since transitions between the ground state of alkali-metal atoms are electric-dipole forbidden. In a hot dense gas, the observed widths are much greater, due primarily to the finite time an atom spends in the laser beam as it moves through

the vapor cell and, to a lesser extent, due to collisions with surrounding atoms that can induce transitions between the states. The transit-time broadening can be reduced significantly by introducing a buffer gas to the vapor cell that reduces the mean-free-path of the alkali-metal atoms. Noble gas elements are preferred because there is little interaction between the buffer gas atoms and the alkali-metal atoms, thereby minimizing collision-induced transitions. Typical buffer gas pressures are of the order of 10 Torr for a 1 mm diameter laser beam.

The final step in achieving narrow EIT resonances involves magnetic shielding. The energy level structure of an alkali-metal atom is more complex than that shown in fig. 13a; for each level there are $(2F + 1)$ degenerate quantum states in zero magnetic field, where F is the total angular momentum quantum number. Because of the Zeeman effect, these states experience a shift in energy of the order of 1 MHz/Gauss. Therefore, to realize an approximation to the idealized three-level atomic system considered in § 3, stray magnetic fields must be reduced to better than 1 mGauss for γ_{at} of the order of 1 KHz. Well-designed containers for the vapor cell constructed from high-permeability metals can achieve such low ambient fields.

Using all of these techniques, Kash, Sautenkov, Zibrov, Hollberg, Welch, Lukin, Rostovtsev, Fry and Scully [1999] were able to attain $\gamma_{\text{at}} \approx 1$ KHz in the laser-pumped rubidium vapor with a 30 Torr neon buffer gas and magnetic shielding. They measured directly the dispersive properties of the vapor using a modulation technique and from this data inferred a group velocity as low as 90 m/s. They did not directly launch pulses of light through the vapor and hence did not address issues related to possible pulse distortion discussed in § 1.1. Some of their results are summarized in fig. 14 where it is seen that the group velocity

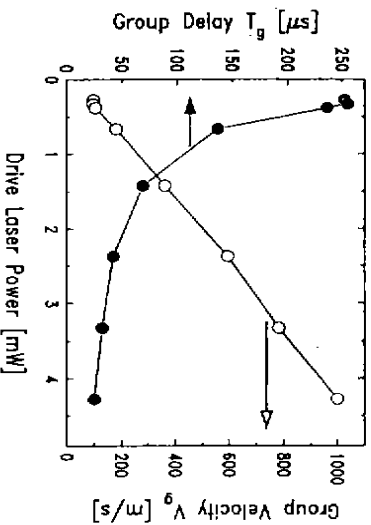

Fig. 14. Experimental results of Kash, Sautenkov, Zibrov, Hollberg, Welch, Lukin, Rostovtsev, Fry and Scully [1999] demonstrating slow-light propagation in a hot atomic vapor.

decreases with decreasing laser power for reasons mentioned above. We note that group velocities as low as 8 m/s have been inferred in a rubidium experiment by Budker, Kimball, Rochester and Yashchuk [1999] using a similar technique.

4.3. "Stopped" light

Liu, Dutton, Behroozi and Hau [2001] have provided experimental evidence that a light pulse can effectively be brought to a halt in a material medium by proper control of the coupling field in an EIT configuration. Such processes hold considerable promise for applications such as coherent optical storage of information.

The coupling configuration used in this work is shown in fig. 15. The propagation of a probe beam tuned near the $|1\rangle - |3\rangle$ transition is monitored in the presence of a coupling beam tuned to the $|2\rangle - |3\rangle$ transition. This experiment

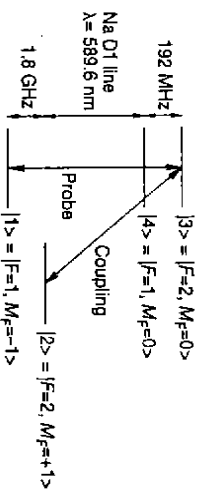

Fig. 15. Energy levels and laser frequencies used in the stopped-light experiment of Liu, Dutton, Behroozi and Hau [2001].

can be understood by noting that the probe beam would be very quickly absorbed were it not for the presence of the coupling beam. This experiment was performed in a laser-cooled atomic sodium vapor near the temperature for Bose-Einstein condensation.

Some of the experimental results of Liu, Dutton, Behroozi and Hau are shown in fig. 16. The upper panel shows three traces. The sharp peak centered at $t = 0$ (dotted line) shows a time reference obtained from the transmission of an input pulse so far detuned from the atomic resonance that it propagates essentially at the velocity of light in vacuum. The smaller peak centered at 12 μ s is the transmitted, delayed pulse obtained under EIT conditions (solid line). The dashed curve shows the time evolution of the saturation field (referred to as the coupling field in the figure).

The lower panels of fig. 16 shows data illustrating the storage of the probe pulse. In this experiment, the coupling field is turned on before the arrival of incident probe pulse. However, at time $t = 10$ μ s after the pulse has fully entered

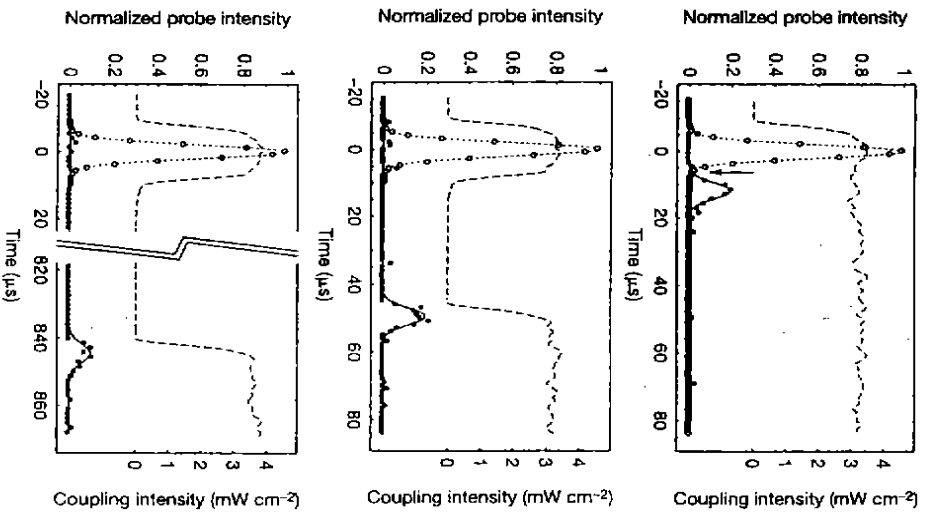

Fig. 16. Experimental results of Liu, Dutton, Behroozi and Hau [2001] showing the stopping of light in an ultra-cold atomic medium. See the text for details.

the interaction region but before it has emerged from the exit side, the coupling field is abruptly turned off and is left off until $t = 45 \mu\text{s}$, at which point it is turned back on. During the time interval in which the coupling pulse is turned off, the probe pulse cannot propagate and remains stored in the medium. We see from the graph that in this case the pulse has been delayed by $25 \mu\text{s}$, the time that the coupling beam has been turned off. In other experiments Liu, Dutton, Behroozi and Hau [2001] have observed pulse delays as long as 1 ms .

The interpretation of this experiment is that when the coupling field is turned

off the probe beam is almost immediately absorbed. The excitation associated with the incident probe beam is not however thermalized: phase and amplitude information regarding the pulse is stored as a coherent superposition of states $|1\rangle$ and $|2\rangle$, that is, knowledge of the incident probe pulse is stored as a ground-state spin coherence. The energy of the probe pulse is coherently scattered into the direction of the coupling field. When the coupling field is later turned on again, light from the coupling field scatters coherently from the ground-state spin coherence to re-create the probe pulse.

Note that the spatial compression of the light pulse as it enters the material medium (as described in § 3.1 above) is crucial to the process of light storage, as it is necessary that the entire pulse be contained within the interaction region. It is largely a matter of semantics whether the light has been temporarily "stopped" within the medium (the wording of the original workers) or whether the light pulse has temporarily been transformed to a material degree of freedom and later turned back into an optical field. It is also worth noting that the physics of the process of light storage is quite similar to that of the generation of Raman echos (Hartmann [1968], Hu, Geschwind and Jedju [1976]).

As in the case of the creation of slow light, one might mistakenly assume that the use of a cold atomic vapor was crucial to the success of the temporary storage of light pulses. In fact, Phillips, Fleischhauer, Mair, Walsworth and Lukin [2001] have demonstrated very similar results through use of a hot Rb vapor.

An additional physical mechanism for stopping the propagation of light has recently been proposed by Kocharovskaya, Rostovtsev and Scully [2001]. This mechanism is based on the spatial dispersion of the refractive index in a Doppler-broadened atomic medium.

§ 5. Experimental studies of fast light

As described above in the discussion of slow light, a practical requirement for the production of slow light is the attainment of a very large *normal* dispersion in the absence of higher-order dispersion and absorption. The natural question arises as to whether it is possible to obtain large *anomalous* dispersion, also with low absorption and low higher-order dispersion, and thereby produce fast (superluminal) light. Recall the work of Chu and Wong [1982a] described above where they observed large anomalous dispersion but in the presence of very large absorption. This work has been extended recently by Akulshin, Barreiro and Lezama [1999] who used electromagnetically induced *absorption* in a driven two-level atomic system to obtain very large anomalous dispersion (with an

inferred v_g of $-c/23\,000$, but still in the presence of large absorption. Another demonstration of superluminal effects, also in the presence of large absorption, has been observed by Steinberg, Kwiat and Chiao [1993] in the context of single-photon tunnelling through a potential barrier.

One possible approach for avoiding absorption is to use the nonlinear (saturation) optical response of an amplifier as in the work of Basov, Ambartsumyan, Zuev, Kryukov and Letokhov [1966] describe above. Alternatively, one can make use of the cooperative (superfluorescence-like) response of a collection of inverted two-level atoms to produce superluminal propagation (Chiao, Kozhokin and Kurizki [1996]). Both of these approaches necessarily require the use of intense pulses. Another approach, described by Bolda, Garrison and Chiao [1994] is to make use of a nearby gain line to create a region of negative group velocity. In the present section, we describe a related scheme that has recently been realized experimentally based on the use of a pair of gain lines.

5.1. Gain-assisted superluminal light propagation

We have seen above how EIT can be used to eliminate probe wave absorption, and in doing so produces slow light. An alternative procedure, proposed initially by Steinberg and Chiao [1994] and recently demonstrated by Wang, Kuznitch and Dogariu [2000] makes use of a pair of Raman gain features to induce transparency and to induce a large dispersion of the refractive index. The sign of $dn/d\omega$ in this circumstance is opposite to that induced by EIT, with the result that the group velocity is negative in the present case.

The details of this procedure are shown in the accompanying figures. Figure 17 shows the energy level description of the experiment. Two pump fields E_1

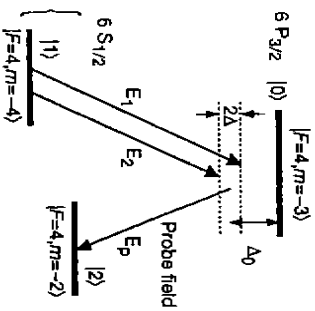

Fig. 17. Energy levels and laser frequencies used in the superluminal pulse propagation experiment of Wang, Kuznitch and Dogariu [2000].

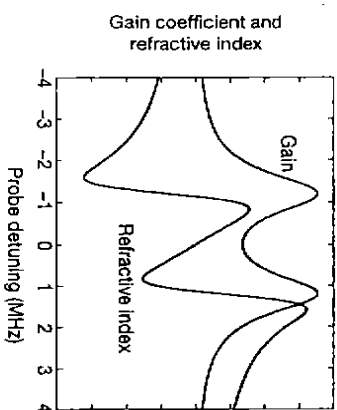

Fig. 18. Theoretically predicted gain spectrum and associated variation of the phase refractive index under the experimental conditions of Wang, Kuznitch and Dogariu [2000].

and E_2 with a frequency separation of 2 MHz are sufficiently detuned from a particular Zeeman component of the cesium resonance line that the dominant interaction is the creation of two Raman gain features. These gain features and the resulting modification of the refractive index are shown in fig. 18. The probe wave is turned midway between these gain features to make use of the maximum dispersion of the refractive index.

Some experimental results are shown in fig. 19. Here the solid curve shows the time evolution of the probe pulse in the absence of the pump beams, and the dashed curve shows the time evolution in the presence of the pump beams. One sees that in the presence of the pump beams the probe pulse is advanced by 62 ns, corresponding to $v_g = -c/310$. The ratio of the pulse advancement to pulse width in this case is of the order of 1.5%. The fractional size of the effect clearly is not large. One of the motivations for performing this experiment was to demonstrate that superluminal light propagation can occur under conditions such that the incident laser pulse undergoes negligible reshaping. Indeed, it is remarkable how closely the input and output pulse shapes track one another. At one time, it had been believed that severe pulse reshaping necessarily accompanies superluminal propagation.

While these experimental results are consistent with semi-classical theories of pulse propagation through an anomalous-dispersion media, there is continued discussion about the propagation of pulses containing only a few photons where quantum fluctuations in the photon number are important. Aharonov, Reznik and Stern [1998] argue that quantum noise will prevent the observation of a superluminal group velocity when the pulse consists of a few photons. In a subsequent analyses, Segev, Milonni, Babb and Chiao [2000] find that a superluminal signal will be dominated by quantum noise so that the signal-to-

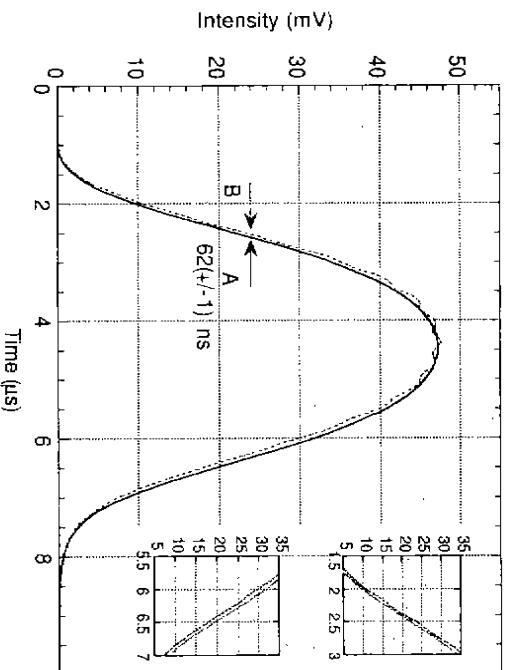

Fig. 19. Experimental results of Wang, Kuzmich and Dogariu [2000], demonstrating superluminal propagation without absorption or pulse distortion. The solid curve shows the pulse propagating through vacuum; the dashed curve shows the transmitted pulse. The insets are blow-ups of the leading and falling edges of the pulse.

noise ratio will be very small, and Kuzmich, Dogariu, Wang, Milonni and Chiao [2001] have introduced a "signal" velocity defined in terms of the signal-to-noise velocity that should be useful for describing the propagation of few-photon pulses. More recently, Milonni, Furuya and Chiao [2001] predict that the peak probability for producing a "click" at a detector can occur sooner than it could if there were no material medium between it and the single-photon source. We await experimental verification of these concepts and predictions.

5.2. Causality

One might fear that the existence of negative group velocities would lead to a violation of the nearly universally accepted notion of causality. Considerable discussion of this point has been presented in the scientific literature, with the unambiguous conclusion that there is no violation of causality, as discussed by Chiao [1993] and by Pearros, Glasgow and Ware [2000]. Thorough reviews of the extended scientific discussion have been published by Chiao [1996] and Chiao and Steinberg [1997].

One can reach this conclusion by noting that the prediction of negative group velocity follows from a frequency-dependent (linear, for simplicity)

susceptibility that is the Fourier transform of a causal time-domain response function. Thus, there is no way that the predictions of such a theory could possibly violate causality. But this argument does not explain how causality can be preserved, for instance, for situations in which the (peak of a) pulse emerges from a material medium before the (peak of the) same pulse enters the medium. The explanation seems to be that any physical pulse will have leading and trailing wings. The distant leading wing contains information about the entire pulse shape, and this information traveling at normal velocities such as c will allow the output pulse to be fully reconstructed long before the peak of the input pulse enters the material medium. For any physical pulse that has a non-compact support, the front velocity is limited to c while the group velocity, signal velocity, etc. can exceed c . For the case in which the front is located close to but before the peak of the pulse and $v_g > c$ or $v_g < 0$, pulse distortion will occur leading to a "pile-up" of the pulse at the front as discussed by Isevigi and Lamb [1969].

The nature of superluminal velocities can also be understood from a frequency domain description of pulse propagation. In such a description, each frequency component is present at all times; the coherent superposition of these frequency components constitute a pulse that is localized in time. When such a pulse enters a dispersive medium, the various components propagate with different phase velocities, leading to pulse distortion and/or propagation with a modified group velocity.

While these ideas have not been tested experimentally for propagation of electromagnetic waves, Mitchell and Chiao [1997] have studied the propagation of voltage pulses through a very low frequency bandpass electronic amplifier. They show that the amplifier transmits Gaussian-shaped pulses with a negative group delay as large as several milliseconds with little distortion, as shown in fig. 20a. They also created an abrupt discontinuity (a front) on the waveform and found that it propagates in a causal manner, as shown in fig. 20b. It is seen that the peak of the output is produced in response to earlier input, which does not include the input peak. This result is expected for a causal system where the output depends on the input at past and present, but not on future times. For a front at the beginning of the pulse, they observe that the front reaches the output no earlier than it reaches the input and that no signal precedes the front, as expected.

In summary, even though $v_g > c$ or $v_g < 0$, relativistic causality is not expected to be violated in electromagnetic wave propagation experiments. Specifically, the front of any physical pulse of compact extent should travel at a speed less than c , and it should distort to avoid overtaking the front, consistent with the dispersion properties of the medium.

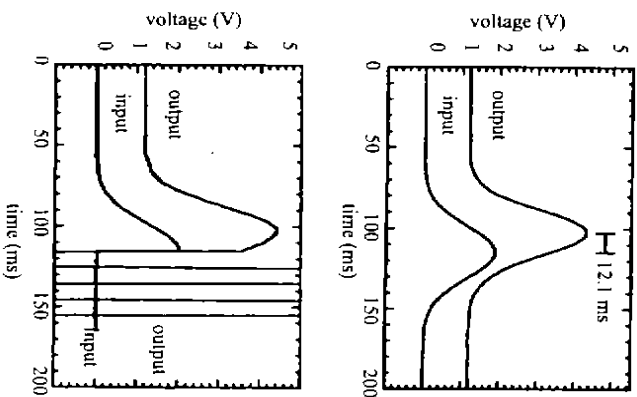

Fig. 20. Experimental results of Mitchell and Chiao (1997) demonstrating negative group delays, but causal propagation. (a) Input/output characteristics of a chain of low-frequency bandpass amplifiers. (b) Input/output characteristics for a pulse with a sharp "back".

§ 6. Discussion and conclusions

This very recent research on slow and fast light demonstrates that our understanding of atom-field interactions has truly developed to a high degree. It is now possible to tailor the absorption, amplification, and dispersion of multi-level atoms using intense electromagnetic fields. The developments are of fundamental interest, and they hold promise for advances in practical areas from optical communications and devices to quantum computing. Fundamentally, they challenge our understanding of century-old physical laws.

Acknowledgements

RWB wishes to thank C.R. Stroud Jr. and R. Epstein for their encouragement in preparing a review of this sort. The authors also wish to thank L.V. Hau, E. Cornell, S.E. Harris, M. Fleischhauer, G.R. Welch, F.A. Narducci, M.O. Scully,

M.D. Lukin, L.J. Wang, and S.L. Olsen for fruitful discussions regarding the content of this review. RWB was supported in part by ONR grant N00014-99-1-0539, and DJG was supported in part by NSF grant PHY-9876988.

References

- Agrawal, G.P. 1995, *Nonlinear Fiber Optics*, 2nd Ed. (Academic Press, San Diego, CA).
- Aharony, Y., B. Reznik and A. Stein, 1998, *Phys. Rev. Lett.* **81**, 2190.
- Akushin, A.M., S. Barreto and A. Lezama, 1999, *Phys. Rev. Lett.* **83**, 4277.
- Basov, N.G., R.V. Ambartsumyan, V.S. Zuev, P.G. Kryukov and V.S. Letokhov, 1966, *Sov. Phys. Dokl.* **10**, 1039 [*Sov. Phys. JETP* **23**, 16].
- Basov, N.G., and V.S. Letokhov, 1966, *Sov. Phys. Dokl.* **11**, 222.
- Bennink, R.S., R.W. Boyd, C.R. Stroud Jr and V. Wong, 2001, *Phys. Rev. A* **63**, 033804.
- Bolda, E.A., J.C. Garrison and R.Y. Chiao, 1994, *Phys. Rev. A* **49**, 2938.
- Boyd, R.W., 1992, *Nonlinear Optics* (Academic Press, San Diego, CA); see, for instance, eq.(6.5.20).
- Brillouin, L., 1914, *Ann. Physik* **44**, 203.
- Brillouin, L., 1960, *Wave Propagation and Group Velocity* (Academic Press, New York).
- Buckler, D., D.F. Kimball, S.M. Rochester and V.V. Yashchuk, 1999, *Phys. Rev. Lett.* **83**, 1767.
- Carruthers, J.A., and T. Bieber, 1969, *J. Appl. Phys.* **40**, 426.
- Casperson, L., and A. Yariv, 1971, *Phys. Rev. Lett.* **26**, 293.
- Chiao, R.Y., 1993, *Phys. Rev. A* **48**, R34.
- Chiao, R.Y., 1996, in: *Amazing Light: A volume dedicated to Charles Hard Townes on his 80th birthday*, ed. R.Y. Chiao (Springer, Berlin) p. 91.
- Chiao, R.Y., A.E. Kozhokin and G. Kuztzi, 1996, *Phys. Rev. Lett.* **77**, 1254.
- Chiao, R.Y., and A.M. Steinberg, 1997, in: *Progress in Optics*, Vol. 37, ed. E. Wolf (Elsevier, Amsterdam) p. 345.
- Chu, S., and S. Wong, 1982a, *Phys. Rev. Lett.* **48**, 738.
- Chu, S., and S. Wong, 1982b, *Phys. Rev. Lett.* **49**, 1293.
- Dienert, G., 1996, *Phys. Lett. A* **223**, 327.
- Dienert, G., 1997, *Phys. Lett. A* **235**, 118.
- Faxvogel, E.R., C.N.Y. Chow, T. Bieber and J.A. Carruthers, 1970, *Appl. Phys. Lett.* **17**, 192.
- Froya, A., M.A. Duguay, C.G.B. Garrett and S.L. McCall, 1969, *J. Appl. Phys.* **40**, 3969.
- Garrett, C.G.B., and D.E. McCumber, 1970, *Phys. Rev. A* **1**, 305.
- Harris, S.E., 1997, *Phys. Today* (July), p. 36.
- Harris, S.E., J.E. Field and A. Imamoglu, 1990, *Phys. Rev. Lett.* **64**, 1107.
- Harris, S.E., J.E. Field and A. Kasapi, 1992, *Phys. Rev. A* **46**, R29.
- Harris, S.E., and L.V. Hau, 1999, *Phys. Rev. Lett.* **82**, 4611.
- Harris, S.E., G.Y. Yin, M. Jain, H. Xia and A.T. Merriam, 1997, *Philos. Trans. R. Soc. London A* **355**, 2291.
- Hartmann, S.R., 1968, *IEEE J. Quantum Electron.* **4**, 802.
- Hau, L.V., S.E. Harris, Z. Dutton and C.H. Behroozi, 1999, *Nature* **397**, 594.
- Hu, P., S. Geschwind and T.M. Jedju, 1976, *Phys. Rev. Lett.* **37**, 1357.
- Isevski, A., and W.E. Lamb Jr, 1969, *Phys. Rev.* **185**, 517.
- Kasapi, A., M. Jain, G.Y. Yin and S.E. Harris, 1995, *Phys. Rev. Lett.* **74**, 2447.
- Kash, M.M., V.A. Sautenkov, A.S. Zibrov, L. Hollberg, G.R. Welch, M.D. Lukin, Y. Rostouev, E.S. Fry and M.O. Scully, 1999, *Phys. Rev. Lett.* **82**, 5229.
- Katz, A., and R.R. Alfano, 1982, *Phys. Rev. Lett.* **49**, 1292.

- Kocherovskaya, O., Y. Rostovtsev and M.O. Scully, 2001, Phys. Rev. Lett. **86**, 628.
- Kuzmich, A., A. Dogariu, L.J. Wang, P.W. Milonni and R.Y. Chiao, 2001, Phys. Rev. Lett. **86**, 3925.
- Lin, C., Z. Dutton, C.H. Behroozi and L.Y. Hau, 2001, Nature **409**, 490.
- Lukin, M.D., and A. Imamoglu, 2001, Nature **413**, 273.
- Milonni, P.W., K. Furuya and R.Y. Chiao, 2001, Opt. Express **8**, 59.
- Mitchell, M.W., and R.Y. Chiao, 1997, Phys. Lett. A **230**, 133.
- Pentross, J., S.A. Glasgow and M. Ware, 2000, Phys. Rev. Lett. **84**, 2370.
- Phillips, D.F., M. Fleischhauer, A. Mair, R.L. Walsworth and M.D. Lukin, 2001, Phys. Rev. Lett. **86**, 783.
- Scully, M.O., 1991, Phys. Rev. Lett. **67**, 1855.
- Segard, B., and B. Macke, 1985, Phys. Lett. **109A**, 213.
- Segev, B., P.W. Milonni, J.E. Babb and R.Y. Chiao, 2000, Phys. Rev. A **62**, 022144.
- Sherman, G.C., and K.E. Oughstun, 1981, Phys. Rev. Lett. **47**, 1451.
- Sommerfeld, A., 1907, Physik. Z. **8**, 841.
- Sommerfeld, A., 1914, Ann. Physik **44**, 177.
- Steinberg, A.M., and R.Y. Chiao, 1994, Phys. Rev. A **49**, 2071.
- Steinberg, A.M., P.G. Kwiat and R.Y. Chiao, 1993, Phys. Rev. Lett. **71**, 708.
- Tewari, S.P., and G.S. Agarwal, 1986, Phys. Rev. Lett. **56**, 1811.
- Wang, L.J., A. Kuzmich and A. Dogariu, 2000, Nature **406**, 277.
- Xiao, H., and K.E. Oughstun, 1997, Phys. Rev. Lett. **78**, 642.
- Xiao, H., and K.E. Oughstun, 1999, J. Opt. Soc. Am. B **16**, 1773.
- Xiao, M., Y.-q. Li, S.-z. Jin and J. Gea-Banacloche, 1995, Phys. Rev. Lett. **74**, 666.

E. Hoff, Progress in Optics 43
 © 2002 Elsevier Science B.V.
 All rights reserved

Chapter 7

The fractional Fourier transform and some of its applications to optics

by

A. Torre

*ENEA, UTS - Tecnologie Fisiche Avanzate, via E. Fermi 45,
 00044 Frascati (Rome), Italy; e-mail: annalisa.torre@jfrascati.enea.it*